

1535nm Microchip Laser Module-300μJ

Model:GT-1535-300

1535nm Microchip Laser Module-300μJ is a eye safer solid laser with 1535nm output wavelength. It has the features of small volume, low power consumption, high reliability and good stability, various temperature range, which proves it is a safe, efficient and stable eye safer laser.



Applications

- ◆Laser range finder
- ◆Meteorological radar

Key Features

- ◆ Passively Q-Switched, Er:Glass
- ◆Eye-safe
- ◆Extremely light
- ◆Super compact design
- ◆Wide operating temperature range

Technical Specifications

Wavelength(nm)	1535
Pulse energy(μJ)	300
Pulse width(ns)	≤5
Repetition rate(Hz)	10
Operating current(A)	12
Beam profile	TEM ₀₀
Weight(g)	12
Dimensions(W×H×L,mm)	25x8x7
Operation temperature(°C)	-40~65
Storage temperature(°C)	-55~80

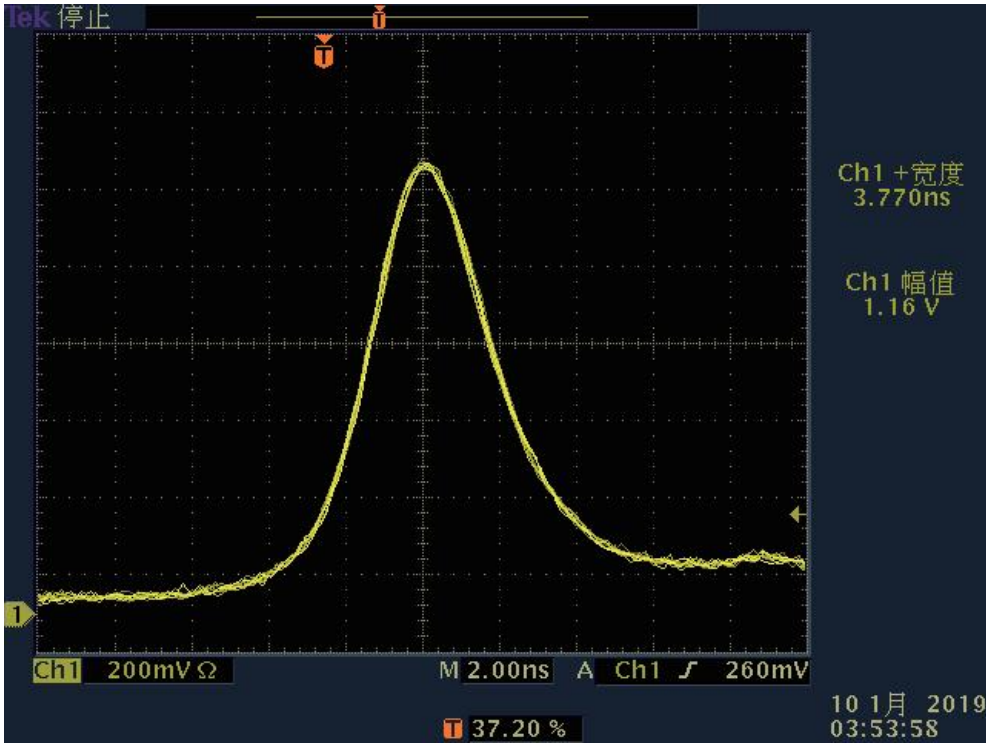

Typical Pluse

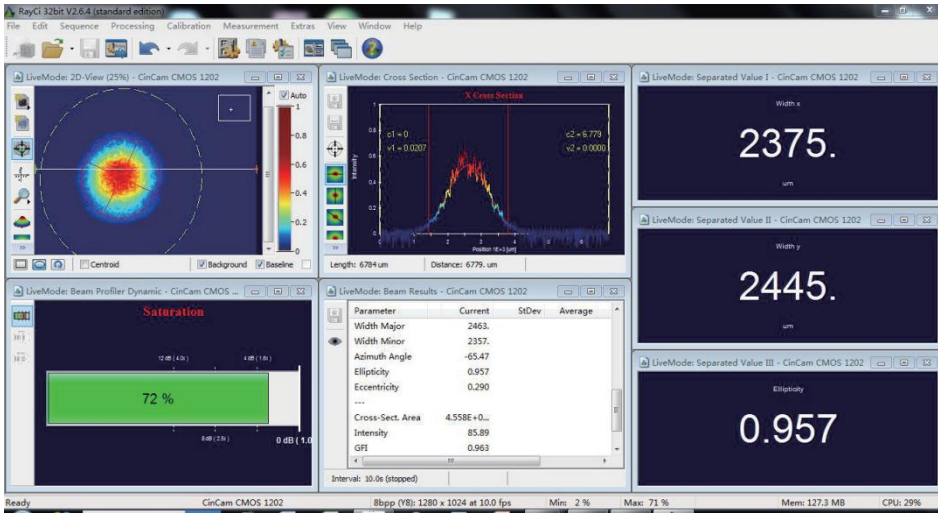

Beam Profile

Part Numbering Schema

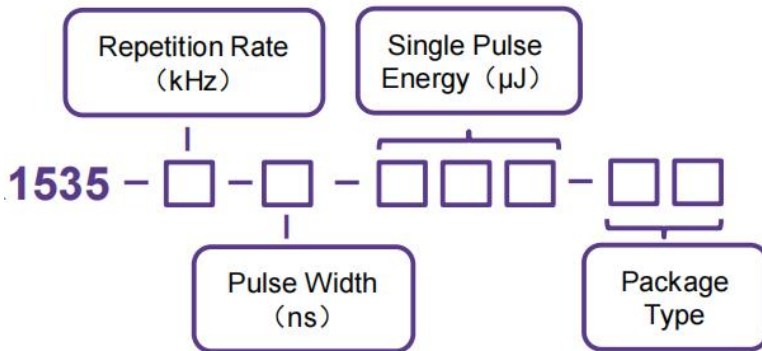

Mechanical Drawings (in mm)

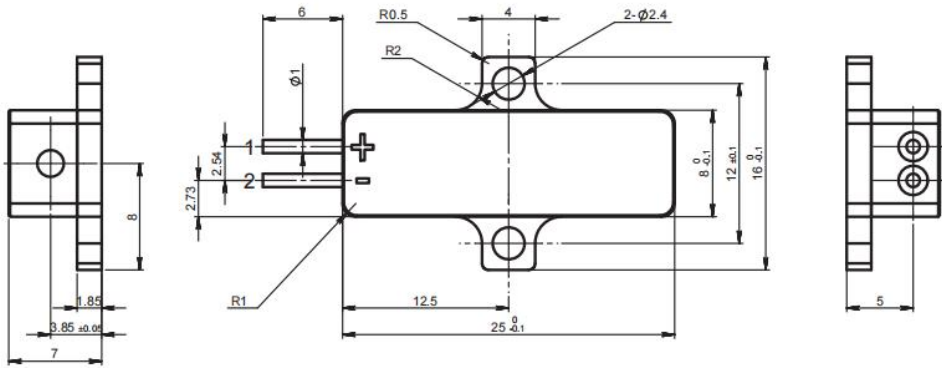

25x8x7mm F2 Drawing

Pin Descriptions

Pin	Function
1	Laser (+)
2	Laser (-)

